

Bath and Inline Fans

SP



UL/cUL 507 - E33599 - Ceiling Exhaust Fans
 Model SP-A390 and smaller and SP-B are
 UL/cUL Listed for above bathtub/shower with
 GFCI branch protected circuit.
 Model SP-C is UL/cUL Listed



UL/cUL Listed 507 is standard on In Stock models.

Model SP is AMCA Licensed for Sound and Air Performance



CSP



UL/cUL 507 - Cabinet Fans - E33599
 Model CSP-A and CSP-B are UL/cUL Listed.



UL/cUL Listed 507 is standard on In Stock models.

Model CSP is AMCA Licensed for Air Performance



Model	Best Available Program
SP-C50 SP-B50 through B200 SP-A50 through A1550	In Stock
CSP-B110 through B200 CSP-A110 through A1550	
SP-L50, SP-L80	1 Day
CSP-A1750 through A3600	
SP-A510-VG, SP-A710-VG CSP-A510-VG, CSP-A710-VG	5 Day

Best Available are 115 volt.

Model SP and CSP Direct Drive

Centrifugal ceiling and inline fans are designed for clean air applications where low sound levels are desired.

Quick Delivery / Quick Build Performance

SP Ceiling capacities range from 50 to 1,600 cfm and 1 in. wg of static pressure.
 SP Wall capacities range from 50 to 80 cfm and 0.625 in. wg of static pressure.
 CSP Inline capacities range from 70 to 3,800 cfm and 1 in. wg of static pressure.

Standard Construction	SP Ceiling			SP Wall	CSP Inline	
	A	B	C	SP-L	A	B
Housing - galvanized steel	■	■	■	■	■	■
Housing - low profile		■	■	■		■
Housing - insulated	■				■	
Wheel - forward-curved	■	■	■	■	■	■
Access panel	■	■	■	■	■	■
Electrical disconnect	■	■	■	■	■	■
Electrical knockouts	■	■	■	■	■	■
Electrical junction box	■	■		■	■	■
Mounting brackets	■	■		■	■	■
Backdraft damper	■	■	■	■	■	■
Flanges - inlet and outlet					■	■
Designer grille - up through size 390	■	■		■		
Aluminum grille - sizes 410 and larger	■	■				

Options and Accessories	Stock	SP Ceiling			SP Wall	CSP Inline	
		A	B	C	SP-L	A	B
Discharge accessory - transitions <i>Available as standard on select sizes</i>	✓	■	■		■	■	■
Discharge accessories - roof, wall	✓	■	■	■	■	■	■
Electrical accessories - speed control, motion detector, time delay	✓	■	■	■	■	■	■
Transformer	✓	■	■	■	■	■	■
Switches - 1 or 2 function		■	■	■	■	■	■
Minimum ventilation controller	✓	■	■	■	■	■	■
Firestat	✓	■	■	■		■	■
Dehumidistat	✓	■	■	■	■	■	■
Isolators - hanging	✓	■	■		■	■	■
Grille - decorative, stainless steel, aluminum	✓	■	■		■		
Lighted grille - SP-A, sizes 50 thru 390 SP-B, sizes 50 thru 200 - Bulbs - compact fluorescent or LED - Lens - frosted, prismatic		■	■				
Filters	✓	■	■		■		
Ceiling radiation damper	✓	■	■				
Contractor 4 Packs - housing and motor packs separate	✓		■				
Motor: • 50 or 60 Hz (select sizes) • 115 or 277 volt (select sizes)		■	■		■	■	■

Products that earn the ENERGY STAR® prevent greenhouse gas emissions by meeting strict energy efficiency guidelines set by the U.S. Environmental Protection Agency and the U.S. Department of Energy.

LEARN MORE AT energystar.gov



Select sizes and models with the Vari-Green® motor are available.

Fans that are ENERGY STAR® qualified include:
 SP-B70, 80 and 90
 SP-A70, 90, 110, 125, 190, 200, 250
 SP-L50 and 80

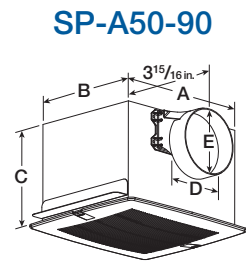
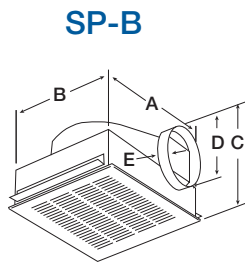
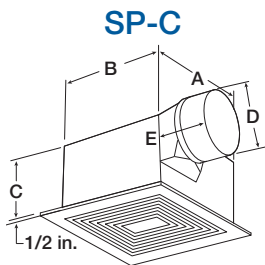

SP-A110 thru 510, 510-VG
SP-A710, 710-VG & 780

SP-A700,
SP-A900 thru 1550

SP-L
50 & 80

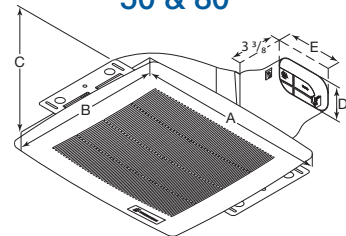
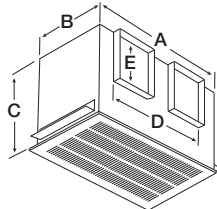
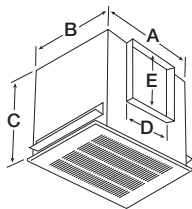

Dimensions for SP

Model Size	A	B	C	Outlet		Grille Size*
				D	E	
SP-C50	7½	7½	3⅝	3	1⅝	9¼ x 9
SP-B50, SP-B70, SP-B80, SP-B90, SP-B110, SP-B150, SP-B200	13⅞	11½	7	6	1¼	14⅞ x 13¼
SP-A50, SP-A70, SP-A90	13¼	10⅝	9	6	6	14⅞ x 13¼
SP-A110, SP-A125, SP-A190	13¼	10⅝	9	8	6	14⅞ x 13¼
SP-A200, SP-A250, SP-A290, SP-A390	14	11⅞	11¼	8	8	14⅞ x 13¼
SP-A410, SP-A510, SP-A510-VG	18	14⅜	14½	8	8	19⅞ x 16⅝
SP-A700	23⅝	11⅞	11⅝	19½	8	25⅞ x 13⅝
SP-A710, SP-A710-VG, SP-A780	18	14⅜	14½	10	8	19⅞ x 16⅝
SP-A900, SP-A1050, SP-A1410, SP-A1550	23¾	14⅜	14½	18⅞	8	25 x 16⅝
SP-L50, SP-L80	13⅞	11½	3⅝	2⅝	4⅞	14⅞ x 13¼

All dimensions are in inches.

*Grille dimensions are for the designer grille except on model SP-C50 where the dimensions are shown for the decorative grille.

CSP-B110-200

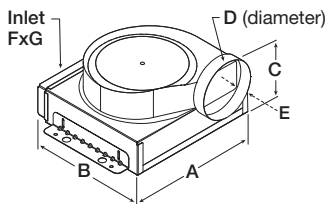

CSP-A110 thru 510 CSP-A510-VG

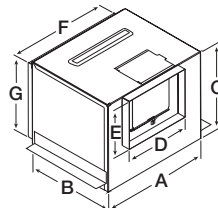

CSP-A700 thru 3600 CSP-A710-VG

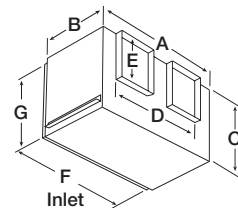

Dimensions for CSP

Model Size	A	B	C	D	E	F	G
CSP-B110, CSP-B150, CSP-B200	13⅞	11½	7	6	1¼	13½	3¼
CSP-A110, CSP-A125, CSP-A190	13¼	10⅝	9	8	6	12	7¾
CSP-A200, CSP-A250, CSP-A290, CSP-A390	14	11⅞	11¼	8	8	12⅞	10
CSP-A410, CSP-A510, CSP-A510-VG	18	14⅜	14½	8	8	16⅞	13¼
CSP-A700	23⅝	11⅞	11⅝	19½	8	22⅞	10½
CSP-A710, CSP-A710-VG, CSP-A780	18	14⅜	14½	10	8	16⅞	13¼
CSP-A900, CSP-A1050, CSP-A1410, CSP-A1550	23¾	14⅜	14½	18⅞	8	22⅞	13¼
CSP-A1750, CSP-A2150	35	14¾	14¾	28	6	32¾	13
CSP-A3600	45½	16½	16½	40	11	43¼	14⅝

All dimensions are in inches.

Discharge Accessories for SP and CSP

RJ-4 and RJ-6x9

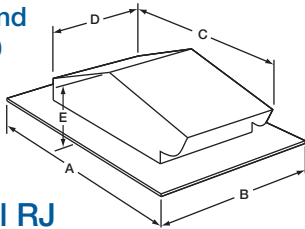

RJ-10x10

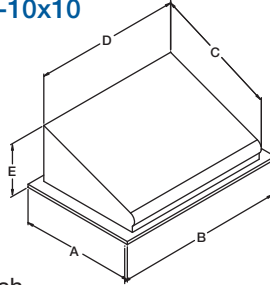

Model RJ Pitched Roof Cap

- Steel construction with black enamel finish
- Integral flashing flange
- Built-in birdscreen and damper

Model	For use with SP-C, SP-B, SP-A SP-L, SP/CSP-A-VG CSP-B, CSP-A	A	B	C	D	E	Throat
RJ-4	Size C50, Size B50 - 80 Size L50, 80	11	9¼	8¼	5½ ₁₆	4½	4 in. dia.
RJ-6 x 9	Size B90 - 200 Size A50 - 390	18¾	14¼	14½	10%	6½	6 x 9
RJ-10 x 10	Size A410 - 1050	18½	27½	15¼	23%	9½	10 x 10

All dimensions are in inches.

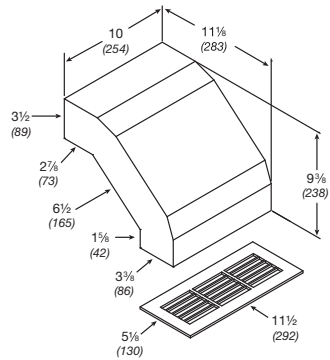

All dimensions are in inches (millimeters).

Model EL-10x3 Elbow Discharge with Grille

- Designed for installation under roof eaves
- Painted steel louvered grille
- Built-in damper
- For SP-C/SP-B/SP-A, sizes 50 - 290
- For SP-L, sizes 50, 80
- For CSP-B/CSP-A, sizes 110 - 290

Model WC Round Connection Hooded Wall Cap

- Aluminum construction - aluminum finish
- For outside wall applications
- Built-in birdscreen (not available on WC-4) and damper

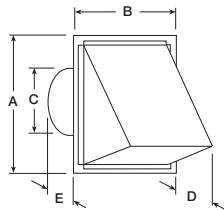

Model	For use with SP-C, SP-B, SP-A SP-L, SP/CSP-A-VG CSP-B, CSP-A	A	B	C	D	E
WC-4	Size C50	6½	6	4	4	5
WC-6	Size B50 - 200 Size A50 - 190 Size L50, 80	8	8	6	4½	5
WC-8	Size A200 - 510	11	11	8	5½	3½

All dimensions are in inches.

Model WC Square/Rectangular Connections Hooded Wall Cap

- Steel construction with black enamel finish
- For outside wall applications
- Built-in birdscreen and damper

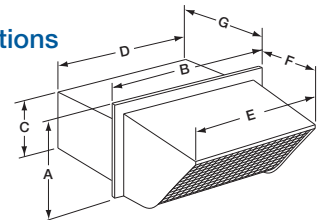

Model	For use with SP-C, SP-B, SP-A SP-L, SP/CSP-A-VG CSP-B, CSP-A	A	B	C	D	E	F	G
WC-10 x 3	Size C50 Size B50 - 200 Size A50 - 290 Size L50, 80	5½	12¼	3½	10¼	11½	4¼	5
WC-8 x 8	Size A390 - 510	10¼	10¼	8¼	8¼	8¼	6¼	5
WC-18 x 8	Size A700 - 1550	10¼	20¼	8¼	18¼	18¼	6¼	5

All dimensions are in inches.

Model WL Wall Louvered Discharge

- Anodized aluminum grille
- Built-in damper
- Not recommended for exterior applications exposed to severe weather conditions. An external wall louver is recommended for such applications.

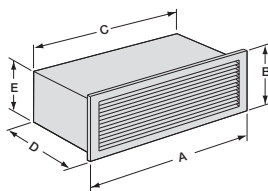

Model	For use with SP-C, SP-B, SP-A SP-L, SP/CSP-A-VG CSP-B, CSP-A	A	B	C	D	E
WL-10 x 3	Size C50 Size B50 - 200 Size A50 - 290 Size L50, 80	12	5¼	10	7¼	3½
WL-18 x 6	Size A390 - 1550	19¼	8	18	9	6

All dimensions are in inches.

Model BVE Brick Vent

- Designed for installation in masonry walls
- Anodized aluminum construction
- Built-in aluminum mesh insect screen

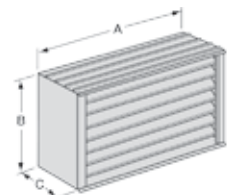

Model	For use with SP-C, SP-B, SP-A SP-L, SP/CSP-A-VG CSP-B, CSP-A	A	B	C
BVE808	Size C50 Size B50 - 200 Size A50 - 290 Size L50, 80	8½	7¼	4
BVE128	Size A390 - 510	12	7¼	4
BVE157	Size A700 - 1050	15½	7¼	4

All dimensions are in inches.

Discharge Accessories for SP and CSP

Curb Cap

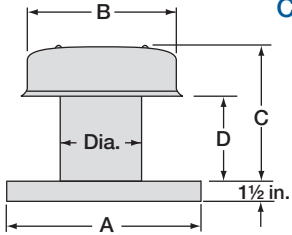

Model RCC-7

- Weathertight aluminum construction
- Integral birdscreen
- Built-in curb cap
- Requires roof curb

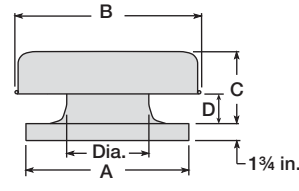

Model GRS

- All aluminum exterior construction
- Galvanized steel internal supports
- Integral birdscreen
- Built-in curb cap
- Requires roof curb

Flashing Flange

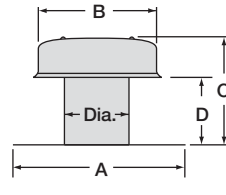

Model RFC-7

- Weathertight aluminum construction
- Integral birdscreen
- Built-in flashing flange

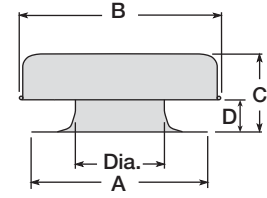

Model GRSF

- All aluminum exterior construction
- Galvanized steel internal supports
- Integral birdscreen
- Built-in flashing flange

Model	For use with SP-C, SP-B, SP-A SP-L, SP/CSP-A-VG CSP-B, CSP-A	A	B	C	D	Dia.
RCC-7	Size C50 Size B50 - 200 Size A50 - 390 Size L50, 80	15	12	10	6 ⁵ / ₁₆	7
GRS-10	Size A410 - 710	19	20 ¹ / ₂	7 ³ / ₄	2	10 ¹ / ₄
GRS-12	Size A780 - 1050	22	29	10	3 ¹ / ₂	12 ¹ / ₄
GRS-16	Size A1410 - 2150	26	29	11	4 ¹ / ₄	16 ⁵ / ₁₆
GRS-20	Size A3600	30	35 ¹ / ₂	11 ¹ / ₄	3 ³ / ₄	20 ⁵ / ₁₆

All dimensions are in inches.

Model	For use with SP-C, SP-B, SP-A SP-L, SP/CSP-A-VG CSP-B, CSP-A	A	B	C	D	Dia.
RFC-7	Size C50 Size B50 - 200 Size A50 - 390 Size L50, 80	18	12	10	6 ⁵ / ₁₆	7
GRSF-10	Size A410 - 710	23	20 ¹ / ₂	7 ³ / ₄	2	10 ¹ / ₄
GRSF-12	Size A780 - 1050	26	29	10	3 ¹ / ₂	12 ¹ / ₄
GRSF-16	Size A1410 - 2150	30	29	11	4 ¹ / ₄	16 ⁵ / ₁₆
GRSF-20	Size A3600	34	35 ¹ / ₂	11 ¹ / ₄	3 ³ / ₄	20 ⁵ / ₁₆

All dimensions are in inches.

Model RDC

Round Duct Connector

- Replaces the standard square discharge duct connector and damper.
- Uses existing mounting holes
- Galvanized steel construction
- RDC-6 includes a damper
- RDC-8 does not include a damper

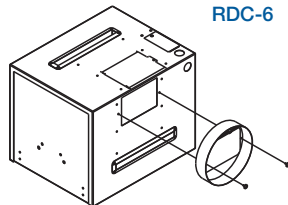

RDC-6

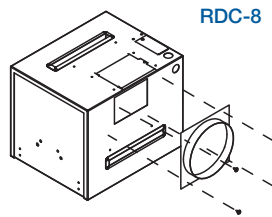

RDC-8

Model	For use with SP-A, CSP-A SP/CSP-A-VG	Dia.
RDC-6	Size A110 - 190	6
RDC-8	Size A200 - 510	8

All dimensions are in inches.

Transition Duct Reducer

- Durable plastic construction

Model	For use with SP-B, SP-A, SP-L CSP-B, CSP-A
473324 6x4 Reducer	Size B50 - 200 Size A50 - 90 Size A110 - 190*
481734 4x3 Reducer	Size L80

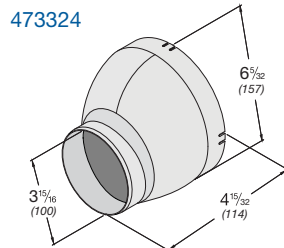

All dimensions are in inches.
Used in conjunction with RDC-6

Accessory Pressure Drops

The chart below can be used with all of the discharge accessories shown on these two pages. Specific pressure drop values for these accessories must be included in total system calculations for proper fan selection.

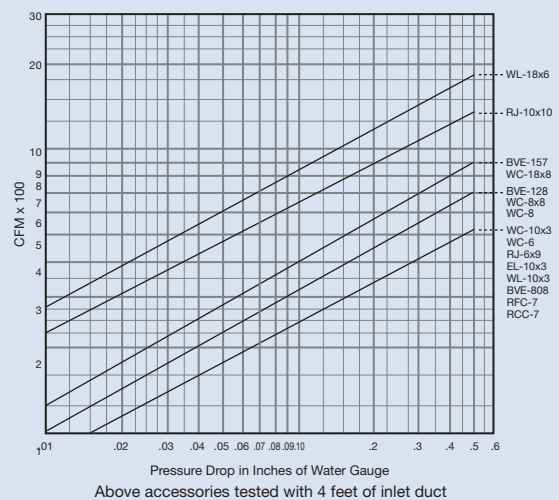

Hanging Vibration Isolators

Vibration isolator kits are available for suspended installations. Kits include all hardware necessary to mount one unit, with the exception of 1/4-20 threaded rod to be supplied by others. Fan mounting brackets include prepunched mounting holes for ease of installation.

Model Size	A	B
B50 - B200	4½	15⅝
A50 - A190	5½	14⅞
A200 - A390	6¾	15½
A410 - A510, A510-VG, A710, A710-VG & A780	9¼	19⅞
A700	5½	25⅝
A900 - A1050, A1410 - A1550	9¼	25⅞
A1750, A2150	9¼	36¾
A3600	9¼	48⅞

All dimensions are in inches.

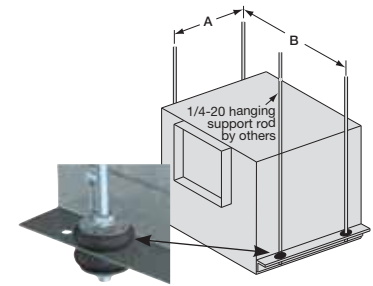

Ceiling Radiation Dampers



The Greenheck SP-A and SP-B ceiling radiation dampers are UL/cUL Classified, rated at three to four hours fire resistance, and are available on all SP-A and SP-B fans and fan/light combinations. This design saves space by allowing the dampers to be mounted directly beneath the fan.

SP Model	CRD	Length	Width	Height
A50 - A190	310	13½	11⅞	3
B50 - B200 A200 - A390	320	14⅞	12¼	3
A410 - A510, A510-VG A710, A710-VG & A780	350	18⅞	14⅞	3
A-700	700	24⅞	12¼	3
A900 - A1550	360	24⅞	14⅞	3

All dimensions are in inches.

Filters

Fans used in most applications, even where air is not excessively dirty, will collect airborne dirt on wheels and motors over time. Accumulations of dirt on the fan wheel will sharply reduce performance and cause imbalance. Dirt buildup on the motor can cause it to overheat. All of these conditions will shorten the life of the fan. To help reduce this accumulation, washable aluminum mesh filters are available to trap dirt before it enters the fan. These filters should be regularly cleaned to maintain performance. The Filter Loss Chart shows the effect the filter will have on performance. To determine the added resistance, divide the desired cfm by the filter area (ft²). This will give FPM. Use this with the filter loss chart to determine the added resistance.

In addition to reducing dirt accumulations on the motor and wheel, filters also reduce sound levels.

SP Model	Filter Model		Filter Area (ft ²)
	Designer Grille	Stainless Steel or Aluminum Grille	
SP-B50 - B200, A200 - A390	F-200	F-220	0.911
SP-A50 - A190	F-200	F-210	0.739
SP-A410 - A510, A510-VG, A710, A710-VG - A780	Not Available	F-250	1.518
SP-A900 - A1550		F-260	2.078

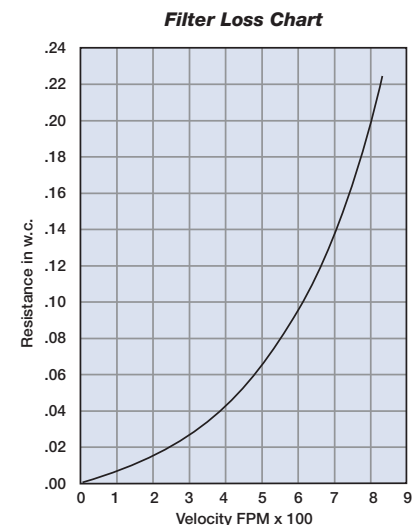
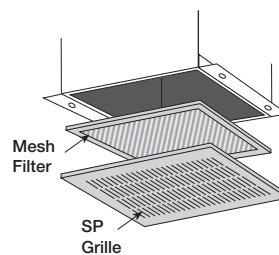

Grilles for Model SP



Designer

Standard on B50-B200, A50-A390
White polystyrene finish. With or without motion detector with time delay.



Decorative

Optional on B50-B200, A50-A390
White plastic finish, with or without light, motion detector with time delay. Lighted grille optional with prismatic or frosted lens.

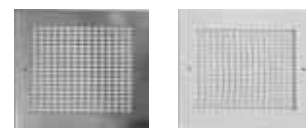

Stainless Steel

Optional on B50-B200, A50-A390
Polished stainless steel finish.

Aluminum

Standard on A410 - A1550, A510-VG, A710-VG
Optional on B50-B200, A50-A390
White enamel finish.