

Rectangular Connection Hooded Wall Cap, Model WC-18x8, For Models SP/CSP

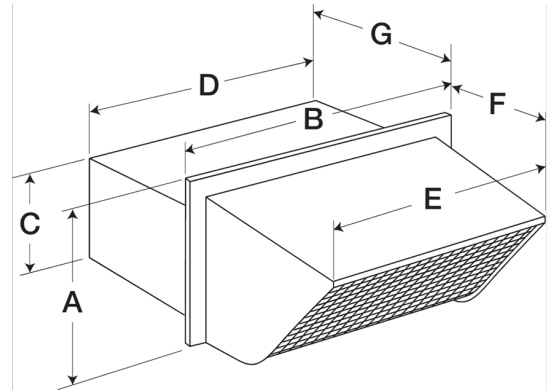

Hooded wall cap with rectangular duct connection designed for outside wall applications. Constructed of steel with black enamel finish, units feature built-in birdscreen and damper.

Certifications



Performance Characteristics

No Fan Curve Available.