

Roof Curb for 17 In. Square Base, for High Wind Applications, 24 In. High

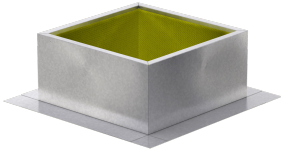

Model GPF roof curbs are designed for high wind applications and flat roof installations. Constructed of heavy gauge galvanized steel and fully formed on three sides with a single, fully welded seam.

- Designed to fit 17" roof curb cap
- 2-inch mounting flange
- Rigid, fiberglass insulation
- Welded, straight-sided construction

Certifications

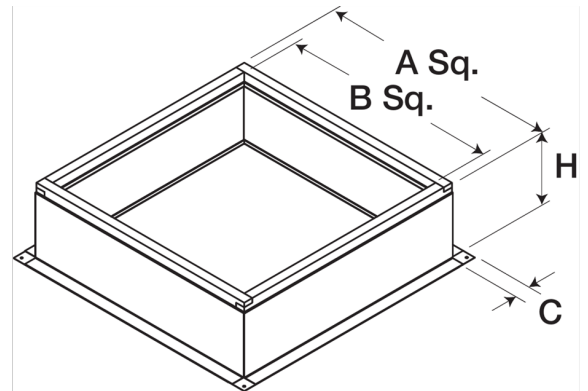

Performance Characteristics

No Fan Curve Available.