

Backdraft damper, vertical mount, Model BD-330, 9 In Sq, No Flange, Performance up to 1,500 ft/min



The BD-330 is a vertical mount backdraft damper designed to allow horizontal airflow and prevent reverse airflow. The dampers are opened by air pressure differential and closed by gravity. The damper features a flangeless, galvanized steel frame with aluminum blades.

- Complies with the International Energy Conservation Code (IECC) and ASHRAE 90.1 leakage requirements for non-motorized dampers
- AMCA certified for Air Leakage and Air Performance
- Width and height furnished approximately 0.125 in. under size

Certifications

AMCA Air &Leakage

Performance Characteristics

No Fan Curve Available.

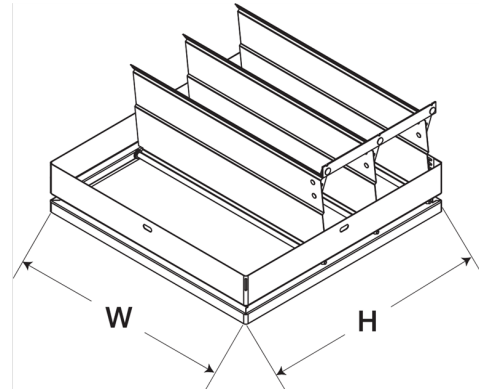

Construction Features

Frame Material	Galvanized Steel
Frame Type	No Flange
Blade Material	Aluminum
Certifications	AMCA Air &Leakage