

Backdraft damper, vertical mount, Model BD-320, 10 In Sq, Flange on Discharge, Performance up to 1,500 ft/min



The BD-320 is a vertical mount backdraft damper designed to allow horizontal airflow and prevent reverse airflow. The dampers are opened by air pressure differential and closed by gravity. The damper features a galvanized steel frame with a flange on the discharge side and aluminum blades.

- Complies with the International Energy Conservation Code (IECC) and ASHRAE 90.1 leakage requirements for non-motorized dampers
- AMCA certified for Air Leakage and Air Performance
- Width and height furnished approximately 0.125 in. under size

Certifications

AMCA Air &Leakage

Performance Characteristics

No Fan Curve Available.

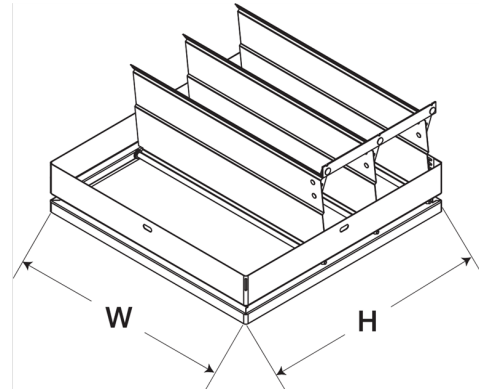

Construction Features

Frame Material	Galvanized Steel
Frame Type	Flange on Discharge
Blade Material	Aluminum
Certifications	AMCA Air &Leakage