

Backdraft damper, horizontal mount, Model BD-100, 18 In Sq, No Flange, Performance up to 1,500 ft/min

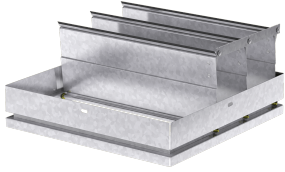

The BD-100 is a horizontal mount backdraft damper designed to allow vertical airflow up and prevent reverse airflow. The dampers are opened by air pressure differential (assisted by springs) and closed by gravity. The damper features a flangeless, galvanized steel frame with aluminum blades.

- Complies with the International Energy Conservation Code (IECC) and ASHRAE 90.1 leakage requirements for non-motorized dampers
- AMCA certified for Air Leakage and Air Performance
- Width and height furnished approximately 0.125 in. under size

Certifications

AMCA Air &Leakage

Performance Characteristics

No Fan Curve Available.

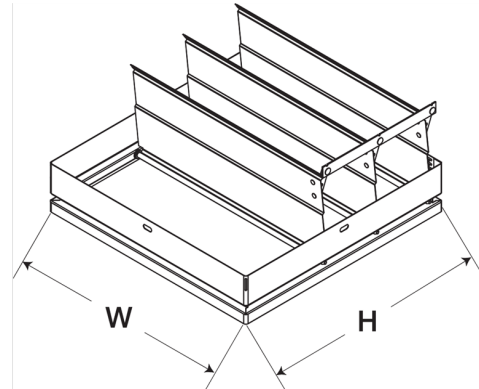

Construction Features

Frame Material	Galvanized Steel
Frame Type	No Flange
Blade Material	Aluminum
Certifications	AMCA Air &Leakage