

# Centrifugal Downblast Exhaust Fan, Model GB-180, Belt Drive, 1/2HP, 115/208-230V, 1Ph, Motor & Drives Unassembled, 1796-3033 CFM



Model GB, belt drive centrifugal roof exhaust fans are designed to meet the general clean air exhaust requirements for industrial and commercial buildings. Units feature a fully rolled windband bead for increased stability and easy transport. Fresh outside air is drawn in under the motor cover to maximize motor life.

- 30 x 30 inch base with prepunched mounting holes for easy attachment to roof curb
- Variable pitch adjustable motor pulley to optimize fan performance
- 26.5 x 26.5 inch recommended roof opening



### Certifications

AMCA Sound & Air  
High Wind and Hurricane  
Seismic  
UL/cUL 705

### Performance Characteristics

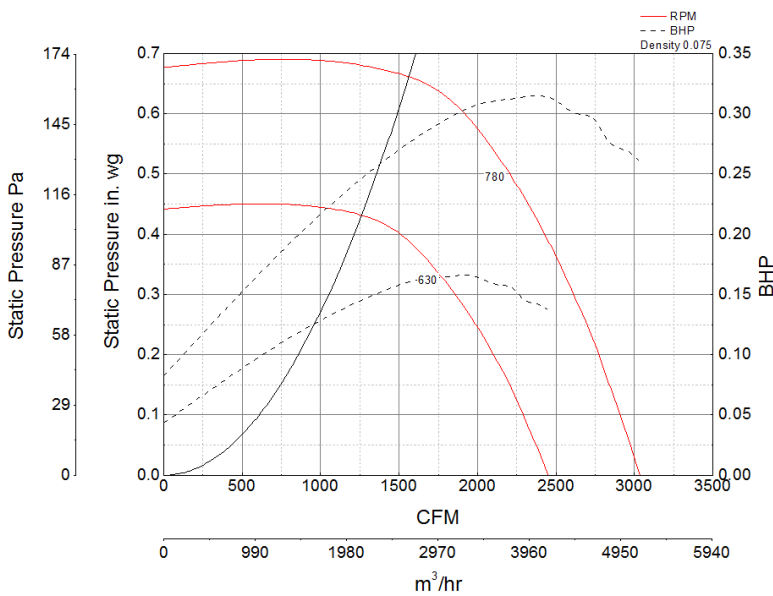

### Construction Features

Drive Type	Belt Drive
Impeller Type	Centrifugal Wheel
Impeller Material	Aluminum
Housing Material	Spun Aluminum
Includes	Unassembled drive package
Certifications	AMCA Sound & Air
Certifications	High Wind and Hurricane
Certifications	Seismic
Certifications	UL/cUL 705
Drive Package Description	Motor and drives shipped loose
Required Accessory	Roof curb for new installations

### Motor Information

Service Factor	1.15
Phase	1
Voltage	115/208-230
HP	1/2
Motor Enclosure	Open Drip Proof
Motor Insulation	B
Thermal Protection	AutoOverload
NEMA Frame Size	48

### Air and Sound Performance

Motor HP	Max BHP	Max Fan RPM	Min Fan RPM	Ps (in. wg)	0	0.125	0.25	0.375	0.5	0.625
1/2	0.31	780	630	CFM	3,033	2,874	2,697	2,478	2,201	1,796
				Sones	8.4	9.6	8.2	8.2	7.8	6.9



- Greenheck Fan Corporation certifies that the model shown herein is licensed to bear the AMCA Seal. The ratings shown are based on tests and procedures performed in accordance with AMCA Publication 211 and AMCA Publication 311 and comply with the requirements of the AMCA Certified Ratings Program.
- Performance certified is for installation type A: Free inlet, Free outlet.
- Power rating (BHP/kW) includes transmission losses.
- Performance ratings include the effects of birdscreen.
- The sound ratings shown are loudness values in fan sones at 5 ft. (1.5 m) in a hemispherical free field calculated per AMCA Standard 301. Values shown are for installation type A: free inlet hemispherical sone levels.